

# OSRAM

## NIGHT BREAKER® LED

H7-LED | 12V  
64210DWNB

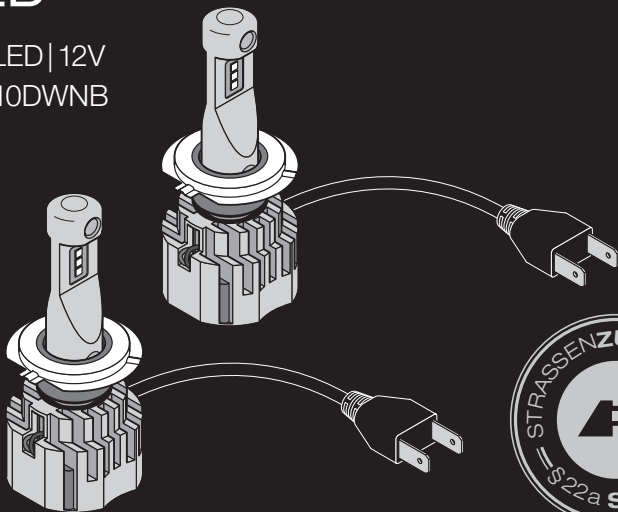



# ALLGEMEINE BAUART- GENEHMIGUNG (ABG) / APPROVAL DOCUMENT



**Kraftfahrt-Bundesamt**

DE-24932 Flensburg

## ALLGEMEINE BAUARTGENEHMIGUNG (ABG)

nach § 22a der Straßenverkehrs-Zulassungs-Ordnung (StVZO) in der Fassung vom 28.08.1988 (BGBl I S. 1793) in Verbindung mit der Verordnung über die Prüfung und Genehmigung der Bauart von Fahrzeugteilen sowie deren Kennzeichnung (FzTV) in der Fassung vom 12.08.1998 (BGBl I S. 2142)

Zugelassenen  
Fahrzeugtyp prüfen.  
Check approved  
vehicle type.

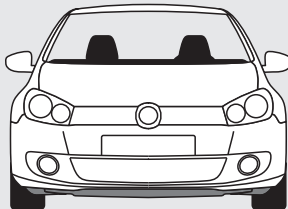
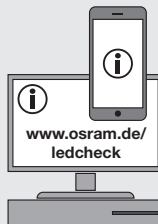

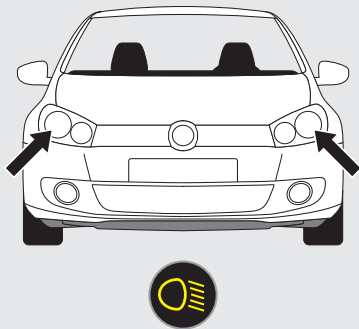
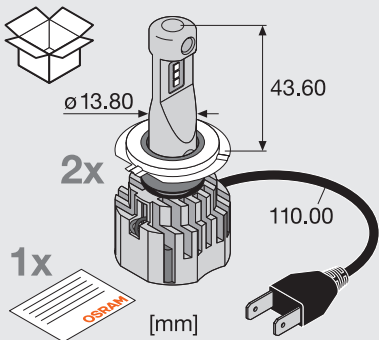

**ABBLENDLICHT / LOW BEAM**

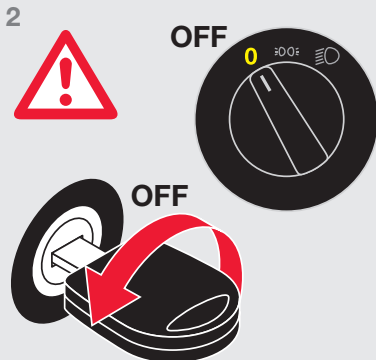
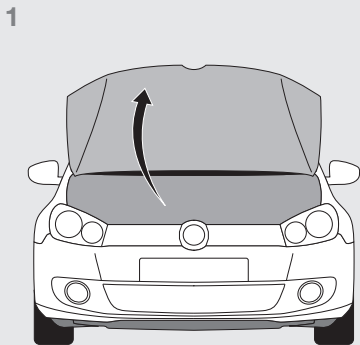

## Option 1: Feder / Spring

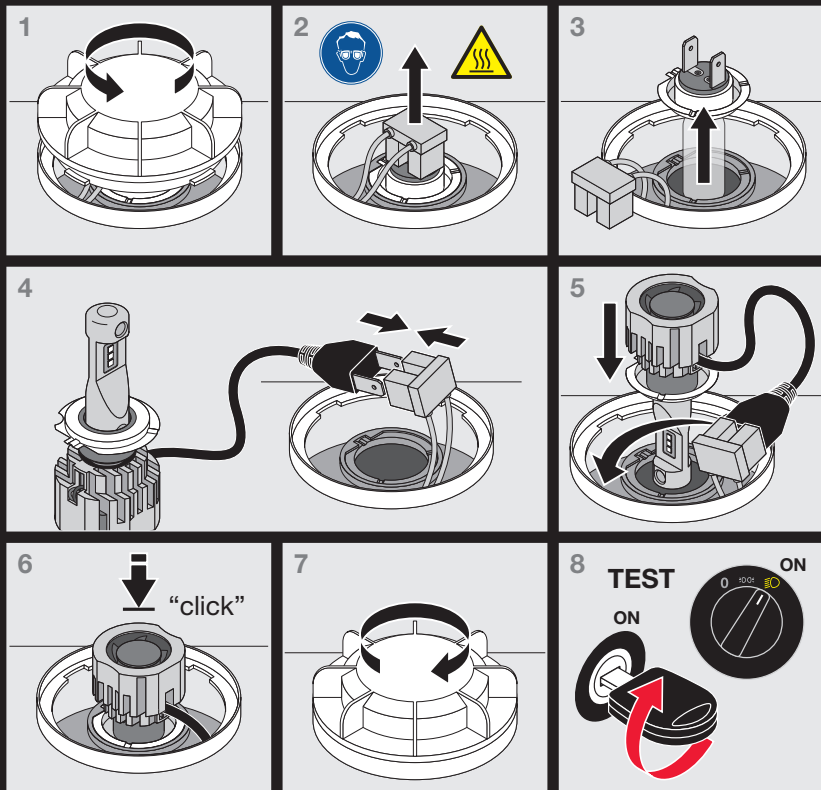

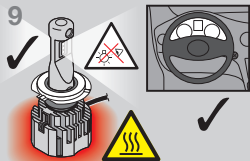

Vorsicht! Das Kühlelement auf der Rückseite heizt sich auf, wenn die Scheinwerferlampe in Betrieb ist.  
 Caution! The cooling element on the back will heat when the headlamp is in operation.

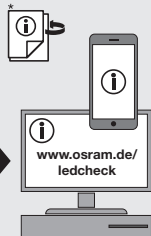
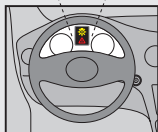

## Option 2: Stahlfeder oder -klammer / Steel spring or clamp

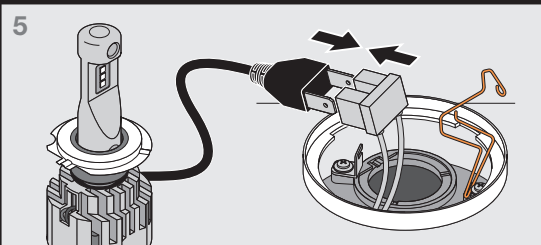
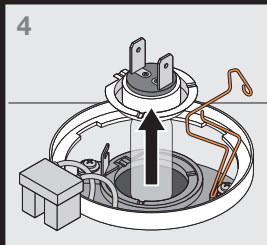
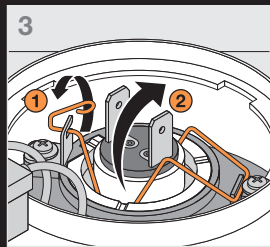
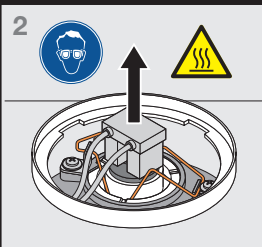
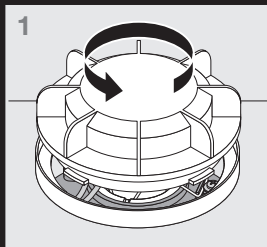

6

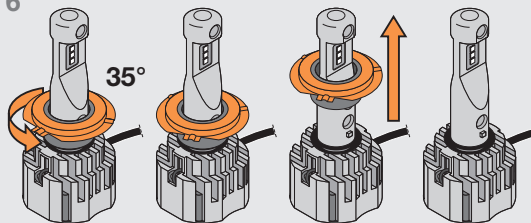

7

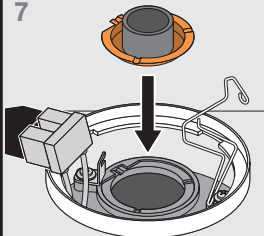

8

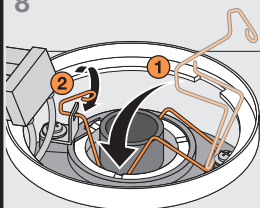

9

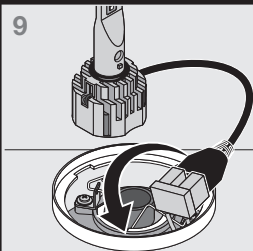

10

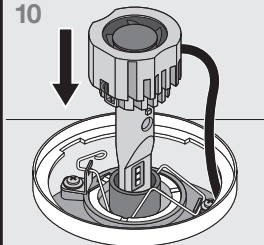

11

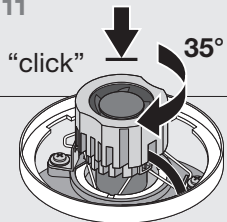

12

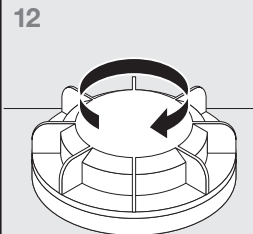

13

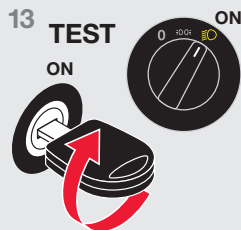

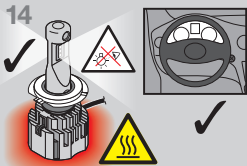

14  
 Vorsicht! Das Kühlelement auf der Rückseite heizt sich auf, wenn die Scheinwerferlampe in Betrieb ist.  
 Caution! The cooling element on the back will heat when the headlamp is in operation.

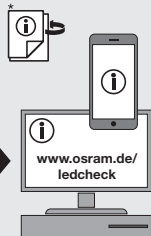
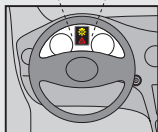

## Option 3: Adapter / Adapter



PKW / Automobile	Adapter
PKW 1	64210DA01
PKW 2	-
...	-
...	-
...	-
...	-
...	-
...	-
...	-
...	-
...	-
...	-
...	-

2

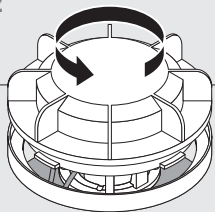

3

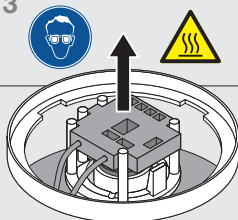

4

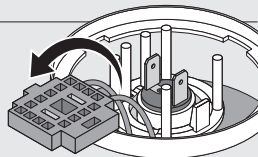

5

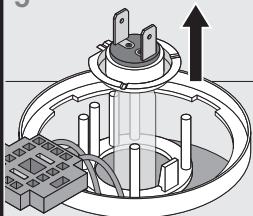

6

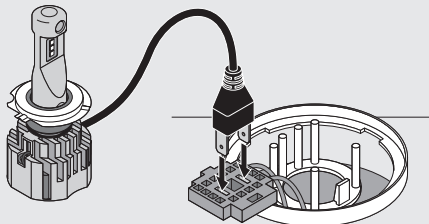

7

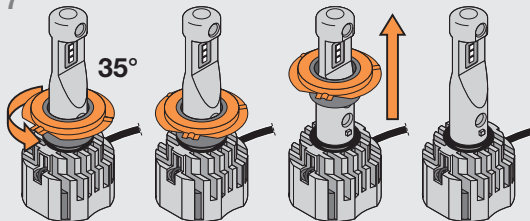

8

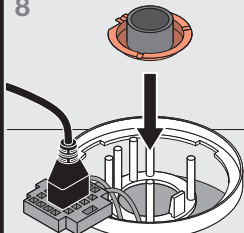



9

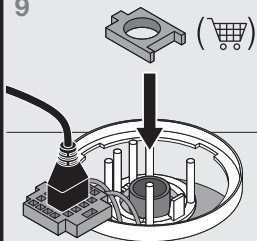

10

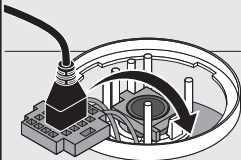

11

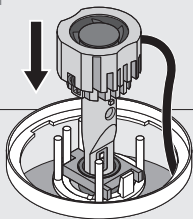

12

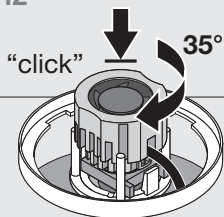

13

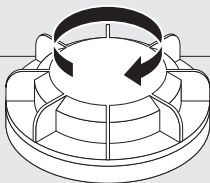

14 TEST

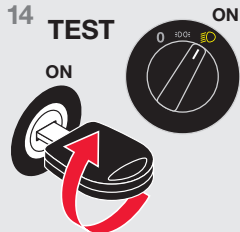

15

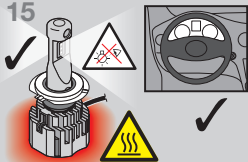

Vorsicht! Das Kühlelement auf der Rückseite heizt sich auf, wenn die Scheinwerferlampe in Betrieb ist.  
Caution! The cooling element on the back will heat when the headlamp is in operation.

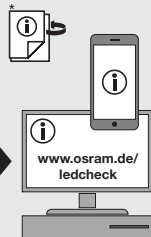
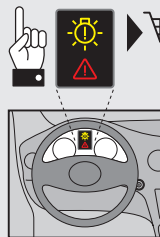

## Option 1 / 2 / 3

### ABG mitführen / Carry ABG



Kraftfahrt-Bundesamt  
DE-44181 Paderborn

ALLGEMEINE BAUARTGENEHMIGUNG (ABG)

**Bitte führen Sie die ausgedruckte Allgemeine Bauartgenehmigung (ABG) stets mit sich, wenn Sie mit dem Fahrzeug unterwegs sind.**

Dieses Produkt darf nur im Rechts-Verkehr verwendet werden. Vor einer Fahrt in ein Land mit Links-Verkehr, z.B. nach England, ist eine Rück-Rüstung auf Halogen-Lampen notwendig.

**Please keep the printed ABG certificate (Allgemeine Bauartgenehmigung) with you at all times while driving the vehicle.**

This replacement lamp is only approved for use in right-hand traffic. Before travelling to a country with left-hand traffic, e.g. England, a re-fitting of the halogen lamps is necessary.

### Teile befestigen / Mount parts

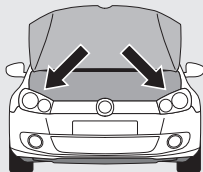

Das Produkt inklusive der Kabel und die Zusatztteile muss so installiert werden, dass es zu keinen Beschädigungen kommt. Achten Sie bitte darauf, dass alle Teile ordnungsgemäß befestigt sind, damit bewegliche Teile oder Funktionen des Fahrzeugs nicht beeinträchtigt werden.

The product inclusive the cables and accessories must be installed in a way that no damages occurs. Please make sure that all parts are fixed properly to avoid interference with any moving part or function of the car.

### Aufkleber anbringen / Attach sticker

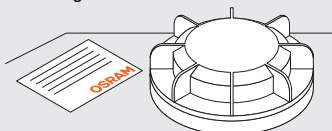

Bitte bringen Sie den mitgelieferten OSRAM-Aufkleber gut sichtbar im Motorraum an.

Please make sure to attach the provided OSRAM sticker in a visible place in the engine compartment.

### Scheinwerfer einstellen / Adjust headlamps



Der Austausch der Scheinwerferlampe erfordert die Anpassung der Scheinwerferereinstellung durch eine qualifizierte Werkstatt. The change of the headlamp requires the readjustment of the headlamp setting by a qualified workshop.



Das Enteisungsverhalten und die Enttaugung können sich aufgrund des Wechsels von Halogen zu LED verändern.

The deicing and defogging behavior can change when switching from halogen to LED.



## NIGHT BREAKER® LED

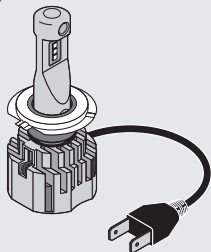

## LEDiving® SMART CANBUS

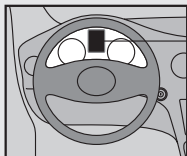
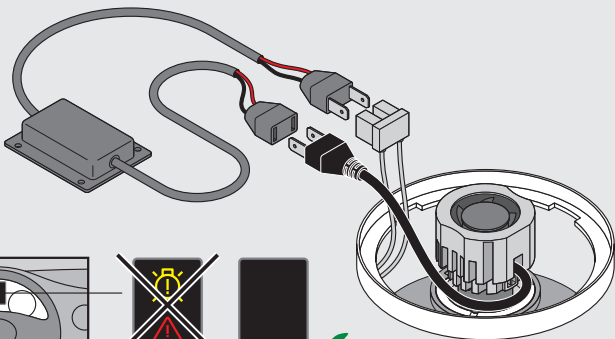
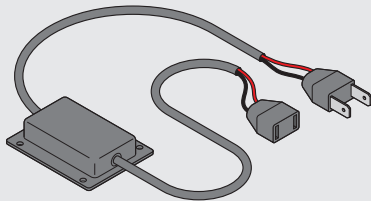

# OSRAM

## NIGHT BREAKER®

### LED

H7-LED | 12V  
64210DWNB



<http://www.osram.com/am-installation>

Bei Fragen bzgl. Wartung oder technischen Problemen wenden Sie sich bitte an den OSRAM Kundendienst via [automotive-service@osram.com](mailto:automotive-service@osram.com)  
For questions regarding maintenance or technical problems, please contact OSRAM customer service via [automotive-service@osram.com](mailto:automotive-service@osram.com)

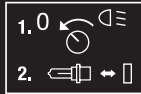
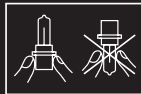

OSRAM GmbH  
Nonnendammallee 44  
13629 Berlin  
Germany  
[www.osram.com](http://www.osram.com)

[www.osram.com/am-guarantee](http://www.osram.com/am-guarantee)

C15082023  
G15086205

05.08.20